

Biosafety Level II Awareness/OSHA Bloodborne Pathogen Training



Albert Einstein College of Medicine

Marian Downing, RBP, CBSP

Acting Biosafety Officer

Class Objectives



- By the end of this class, you will:
 - Understand the function and how to use a biological safety cabinet
 - Understand common laboratory hazards and how to protect yourself
 - Know steps to take in an accidental exposure and/or spill situation
 - Know how to properly dispose of biological waste
 - Have your questions answered about the Hepatitis B vaccine

OSHA Bloodborne Pathogen Rule

- Exposure Control Plan
 - List of job titles exposed/not exposed
- Written Biosafety program
- Annual training
 - On line training every other year
- Offer the Hepatitis B Vaccine
- Provide personal protective equipment
- Utilize engineering controls
- Provide exposure follow-up/counseling

In Yellow Booklet



Other Regulatory Guidance



- NIH Recombinant Guidelines
 - Apply to all institutions receiving NIH funding
 - Covers rDNA work, but also includes risk group listing
- BMBL (Biosafety in Microbiological and Biomedical Laboratories)
 - Guidelines that are not optional
- Select Agent Law (also covers toxins)
- Dangerous goods shipping regulations

What is Biosafety?

- Safety measures applied to the handling of biological materials or organisms with a known potential to cause disease in humans



Risk Group/Biosafety Level

- Risk Group corresponds to the level of hazard associated with the agent
 - NIH Guidelines
 - American Biological Safety Assoc. webpage
- Biosafety Level corresponds to the facility design, PPE and practices required to handle the agent

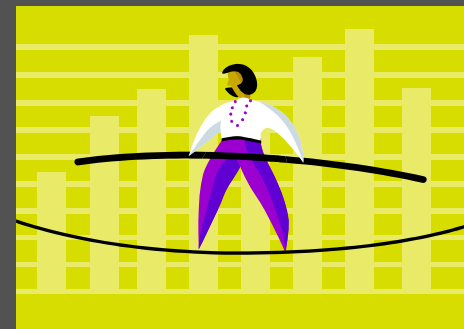

BioSafety Levels

- Distinct categories of biosafety levels (BSL) 1-4 for handling infectious agents
 - Described in CDC/NIH, "Biosafety in Microbiological and Biomedical Laboratories (BMBL)"
 - Risk group may not correspond directly to the biosafety level
 - Established risk groups may vary by country
 - The biosafety level to handle a specific infectious agent is determined by risk assessment

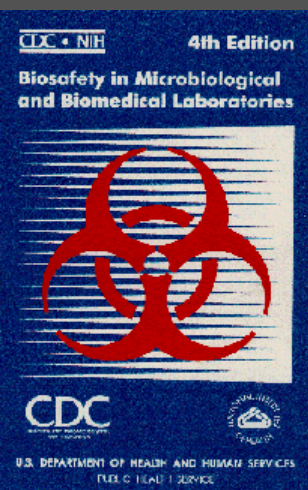

Risk Group listing from ABSA website (for bacteria causing Hanson's Disease - leprosy)

Plant Pathogen: No		Select Agent USDA: No
MSDS:		
Genus: Mycobacterium		Species: leprae
	Risk Group Level	Notes
Australia/New Zealand 2002:		
Belgium 2004:	3	
Switzerland 2003:	3	
United Kingdom 2004:	3	V
Germany 2001:	3	AR
NIH 2002	2	
European Community 2000:	3	
Singapore 2004:	3	Singapore Schedule:
Japan:	2	
Human Pathogen: Yes		Select Agent CDC: No
Animal Pathogen: No		Select Agent USDA: No
Plant Pathogen: No		
MSDS:		
Genus: Mycobacterium		Species: lepraemurium
	Risk Group Level	Notes

<http://www.absa.org/riskgroups/index.html>

BioSafety Levels

■ Agents handled in BSL1

- Not known to cause disease in healthy adult humans
- e.g., non-pathogenic *E. coli*, Lactobacillus

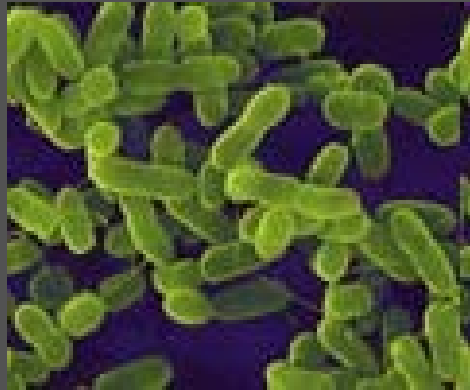

E. coli (lbl.gov)



Lactobacillus (CDC)

BioSafety Levels

■ Agents handled in BSL2

- Associated with human diseases
- e.g. *Salmonella typhimurium*, *Cryptococcus neoformans*, HIV and HCV clinical samples
- Human products (blood, tissue, human cell lines)



Color-enhanced scanning electron micrograph showing *Salmonella typhimurium* (red) invading cultured human cells



Model of HIV virion

BioSafety Levels

- Agents handled in BSL3
 - Indigenous/exotic agents
 - Associated with human disease
 - Potential for aerosol transmission in the lab
 - Often vector-borne
 - e.g. *M. tuberculosis*, Lyme disease, West Nile virus

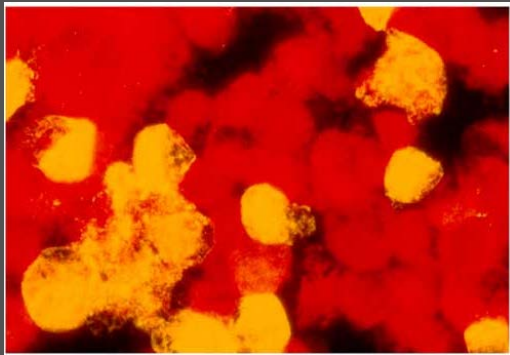

West Nile Virus



Mosquito vector

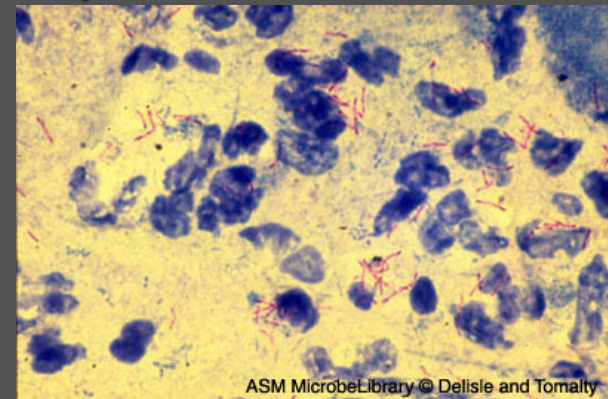

Acid Fast Stain of *M. tb*

BioSafety Levels

■ Agents handled in BSL4

- Most dangerous/exotic agents of life threatening nature
- e.g., Ebola virus, Marburg virus, Lassa virus
- Either a "suit" lab or use Class III BSCs

Lassa Virus

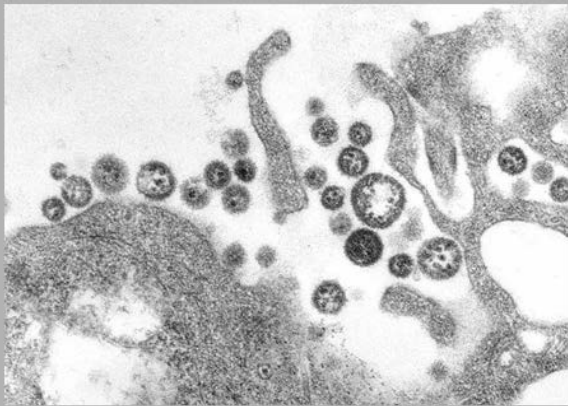
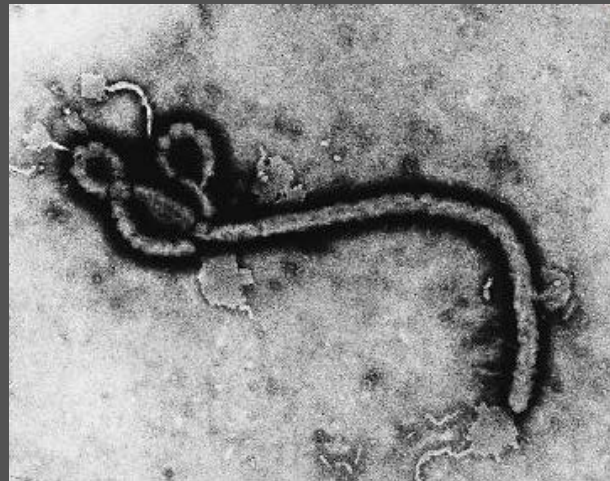

Image source: C.S. Goldsmith and M. Bowen (CDC).



Ebola virus



BSL4 Suit Lab

Facility Design (BMBL)

- BSL-1
 - Basic lab with sink for handwashing
- BSL-2 (e.g., hospital laboratory)
 - May also have a biological safety cabinet, door signage, non-recirculated air, etc.
- BSL-3
 - Neg. pressure, monolithic, sealed, 2X door entry, security, alarms, integral autoclave, etc.

How do you protect yourself?

- Engineering controls
 - Biological Safety Cabinets, sharps containers, safe sharps, centrifuge safety cups, etc.
- Work practices
 - Handwashing, aerosol avoidance, decontaminating work surfaces, etc.
- Personal protective equipment (PPE)
 - Lab coat, gloves, safety glasses, respirator

Know your "hoods"!

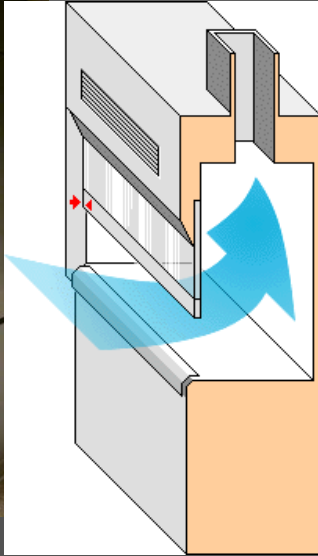

Chemical Fume Hood

- Closes completely
 - Either horizontally or vertically
- Not meant for sitting
- Negative pressure
- May have solvent/chemical storage underneath



Biological Safety Cabinet (BSC)

- Fixed sash opening (8 in.) (alarmed)
- Designed for seated work
- Negative pressure
- Check manufacturer label for type of cabinet

Laminar flow clean air center

- HEPA filter visible in rear or top of unit
- Usually no sash or sash is fixed
- Positive pressure – air blowing into face or breathing zone



Biological Safety Cabinet (BSC)

Primary Containment

- Role:
 - To protect the user from the samples
 - To protect the environment from the samples
 - To protect the samples from external elements



Biosafety Cabinets (a.k.a. tissue culture "hood")

- There are 3 classes of BSC
 - Class I: not often used
 - Class IIA and B: most often found in laboratories
 - Class III: primarily BSL4
- Certification:
 - When new and then annually
 - When moved
 - After repairs, filter changes
 - User contact: TSS (Tech Safety Svc)

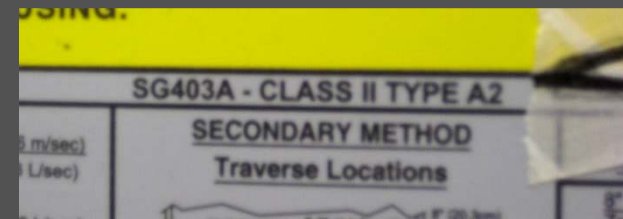
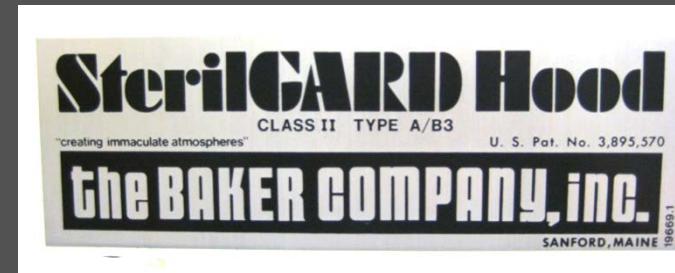

HEPA Filters

High-Efficiency Particulate Air filter

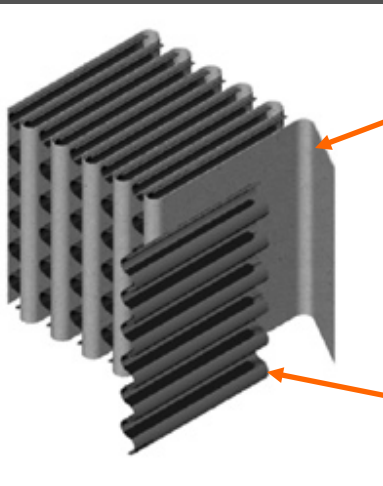

Borosilicate filter medium

Aluminum separator



Wooden frame

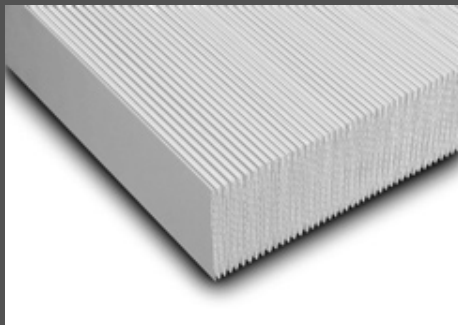

Continuous sheet of flat filter medium

Figure 3. Air Filtration Theory Particle Collection Mechanisms

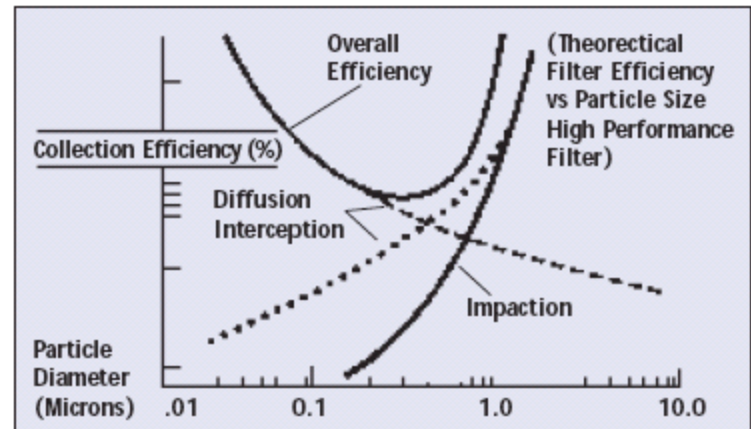
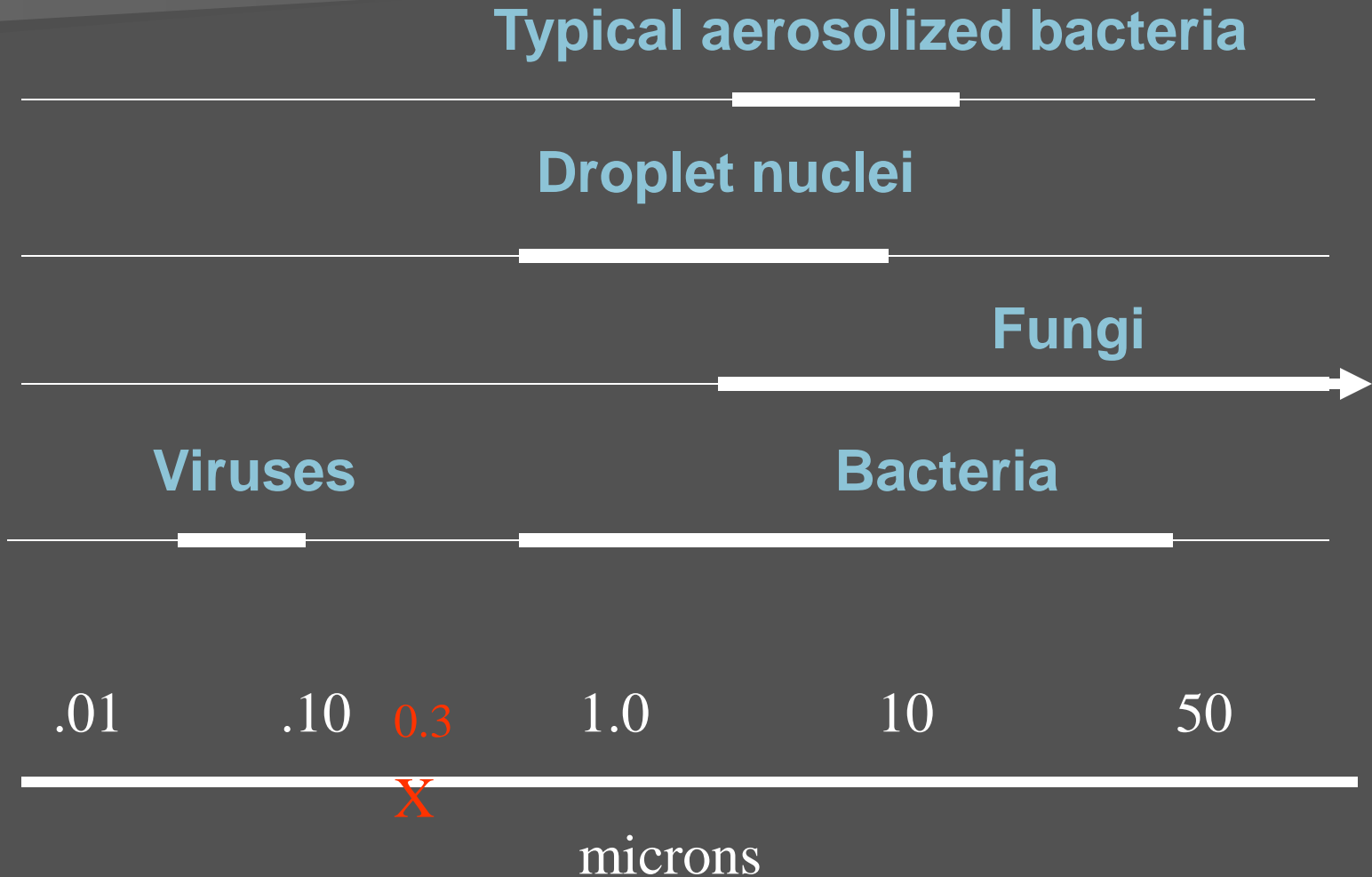

Figure 4. Relative Effect of Particle Collection Mechanism

Labconco

Particle Size Ranges



Function of HEPA

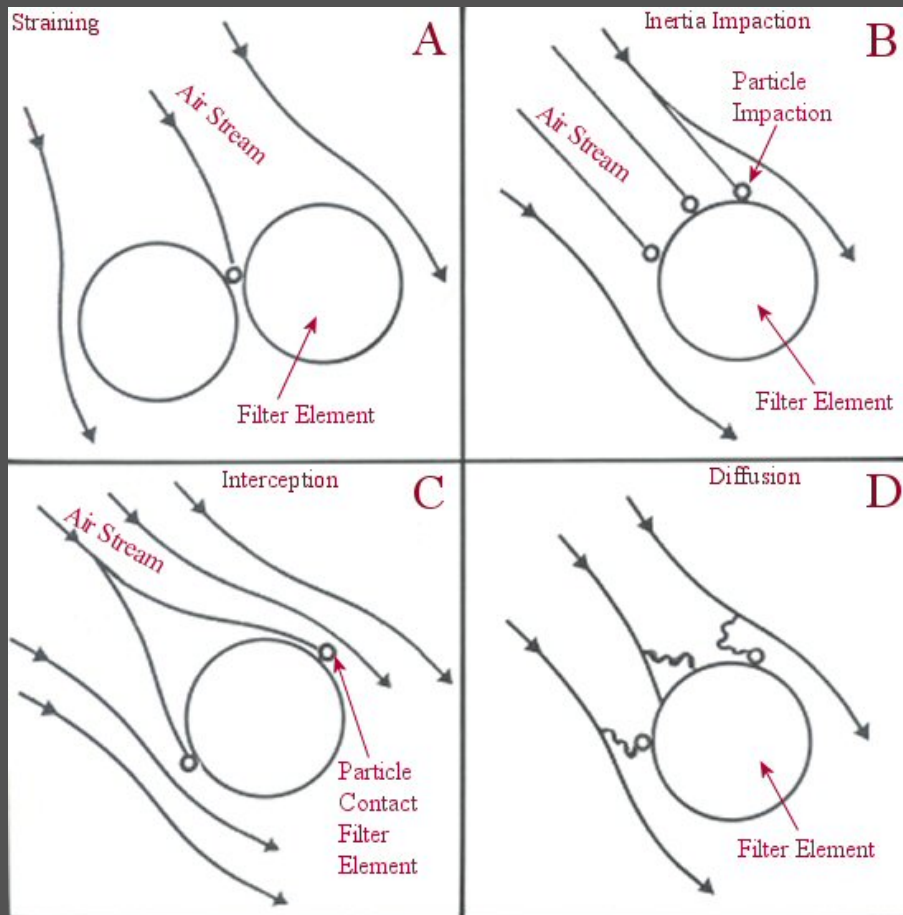

- Particles removed by:
 - **Inertia impaction**
 - **Interception**
 - **Diffusion**
 - **Straining**
- Particles attach by electrostatic (Van der Waals) forces
 - **difficult to dislodge**
 - (unlikely that a properly functioning HEPA is the cause of contamination)

Class I BSC

- Is a negative-pressure ventilated cabinet
 - User and the environment is protected
- Open in the front with a sash
- Inward flow air is not filtered
 - Sample not protected
- Cabinet air HEPA filtered and 100% exhausted to the lab or outside
- Used with low risk infectious agents
- Used to contain mixers, blenders, centrifuges



Nuair

Class I BSC

The Class I BSC. A. front opening, B. sash, C. exhaust HEPA filter, D. exhaust plenum. Note: The cabinet needs to be hard connected to the building exhaust system if toxic vapors are to be used

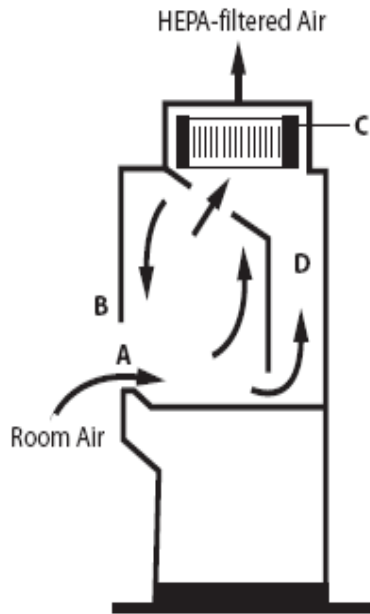

Labconco

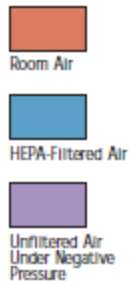

Class II BSC

- Most commonly found BSC in laboratories
- HEPA-filtered vertical laminar air flow
 - User and sample protected
- HEPA-filtered exhausted air
 - User and environment protected
- There are 2 types and 2 subtypes (A1, A2 and B1, B2)





Class II A1-2 BSC

- 70% recirculated air through HEPA filter
- A1 may not be used with volatile toxic chemicals or radionuclides
 - Minute amounts of nonvolatiles may be used
- A2 may be used with nonvolatile toxic chemicals or radionuclides
 - minute levels of volatile toxic chemicals and radionuclides
 - If exhausted outside
 - A2 has higher face velocity than A1



Ethanol fire in BSC (AIHA)

Class II A1 BSC

-  Room Air
-  HEPA-Filtered Air
-  Unfiltered Air Under Negative Pressure
-  Unfiltered Air Under Positive Pressure

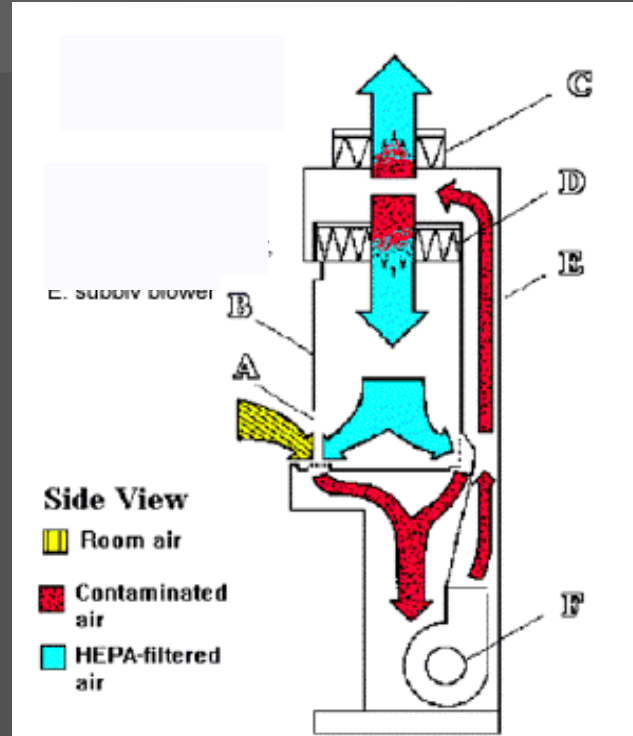
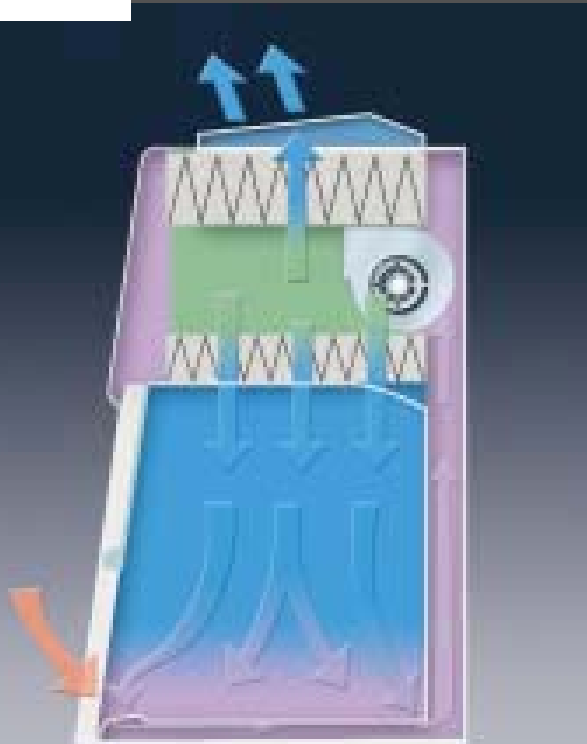

Side View

-  Room air
-  Contaminated air
-  HEPA-filtered air

- A. Front opening
- B. Sash
- C. Exhaust HEPA filter
- D. Supply filter
- E. Rear plenum
- F. Supply blower

CDC drawings



Baker cage changing station

Labconco

Class II A2 BSC

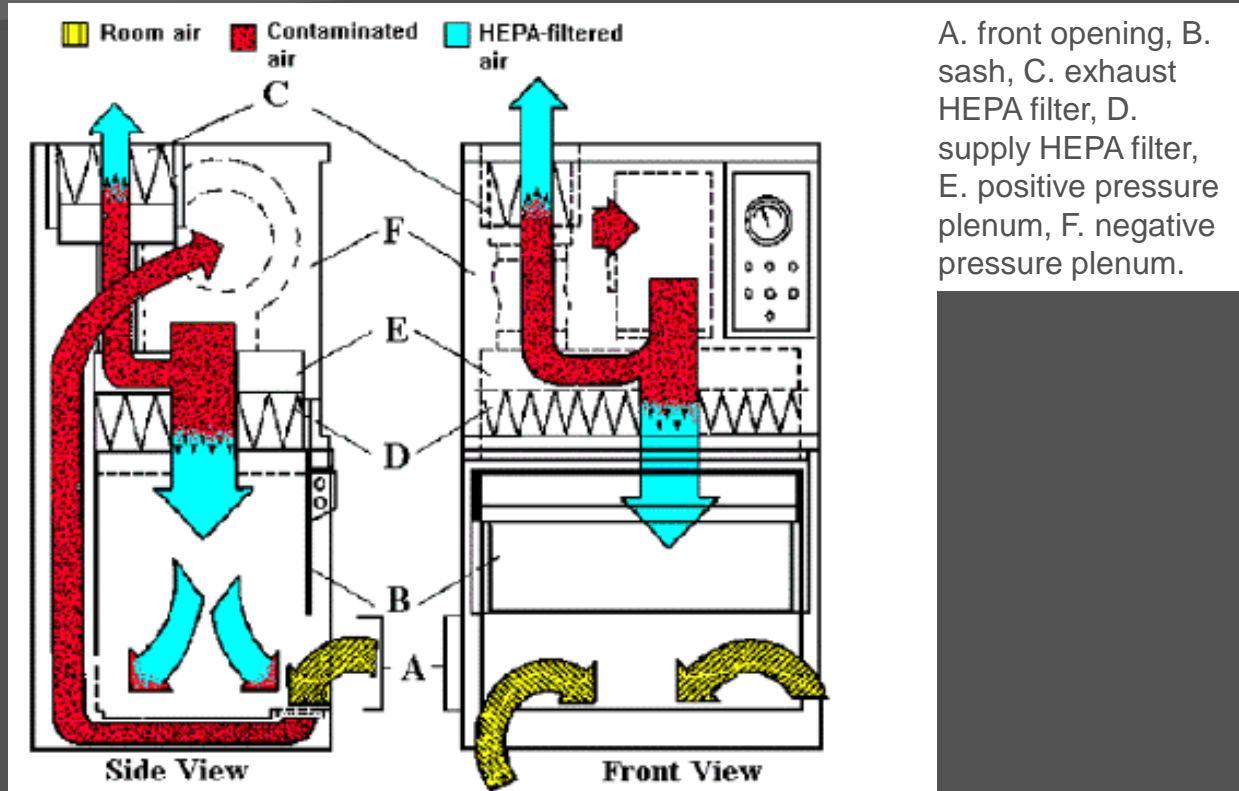

A. front opening, B. sash, C. exhaust HEPA filter, D. supply HEPA filter, E. positive pressure plenum, F. negative pressure plenum.

Baker



The Class II, Type A2 BSC may be connected to the building exhaust system.

CDC drawings

Ducting of BSCs

B. flexible connector to exhaust system, C. cabinet exhaust HEPA filter housing, D. canopy unit, E. BSC.

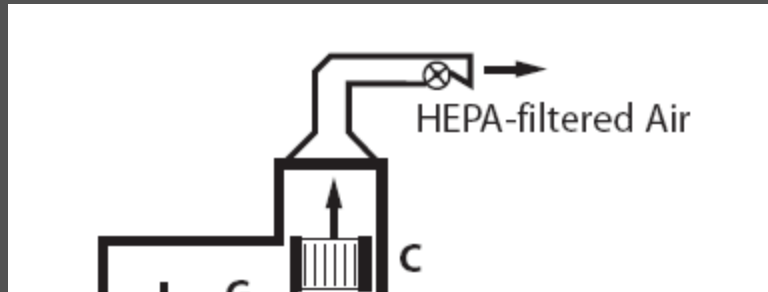

Hard ducting to building exhaust system

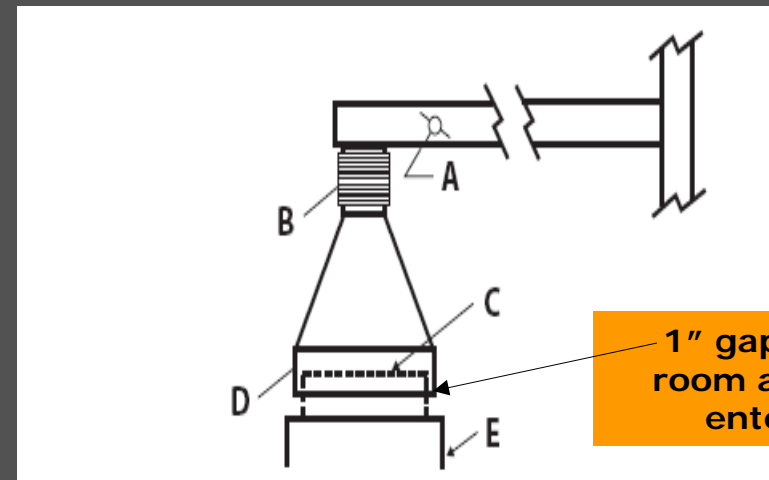

"Thimble" or "canopy" ducting to building exhaust system

(e.g., Class II, A2 BSC)

Class II B1-2 BSC

all "hard ducted"

■ B1

- 30% recirculated air through HEPA filter
- May be used with:
 - Minute levels of volatile toxic chemicals & radionuclides
 - Nonvolatile radionuclides & toxic chemicals

■ B2

- No recirculation of air
- May be used with:
 - Low levels of volatile toxic chemicals & radionuclides
 - Nonvolatile toxic chemicals & radionuclides

Class II B1 BSC

A. front opening, B. sash, C. exhaust HEPA filter, D. supply plenum, E. supply HEPA filter, F. blower, G. negative pressure exhaust plenum. Note: The cabinet exhaust needs to be connected to the building exhaust system.

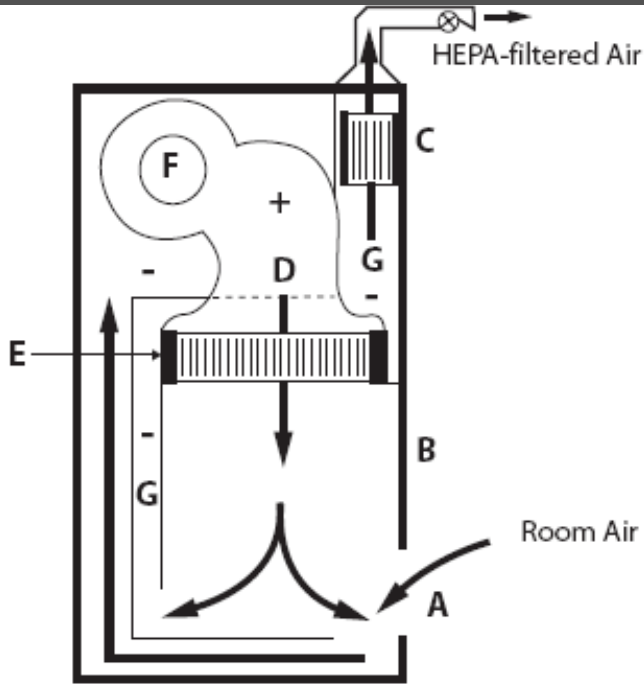

CDC drawing

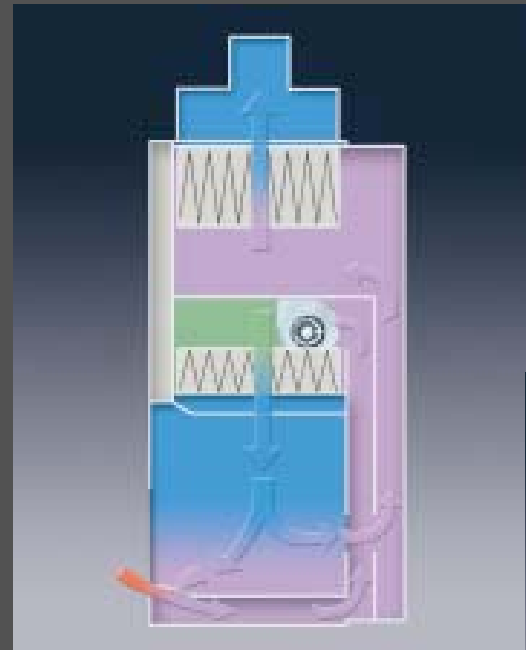

Labconco

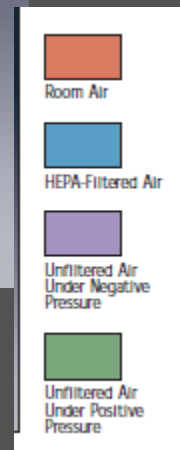

Nuair

Class II B2 BSC

Figure 6. The Class II, Type B2 BSC

A. front opening, B. sash C. exhaust HEPA filter, D. supply HE
 E. negative pressure exhaust plenum, F. blower, G. filter screen,
 NOTE: The cabinet exhaust needs to be connected to the building exhaust system

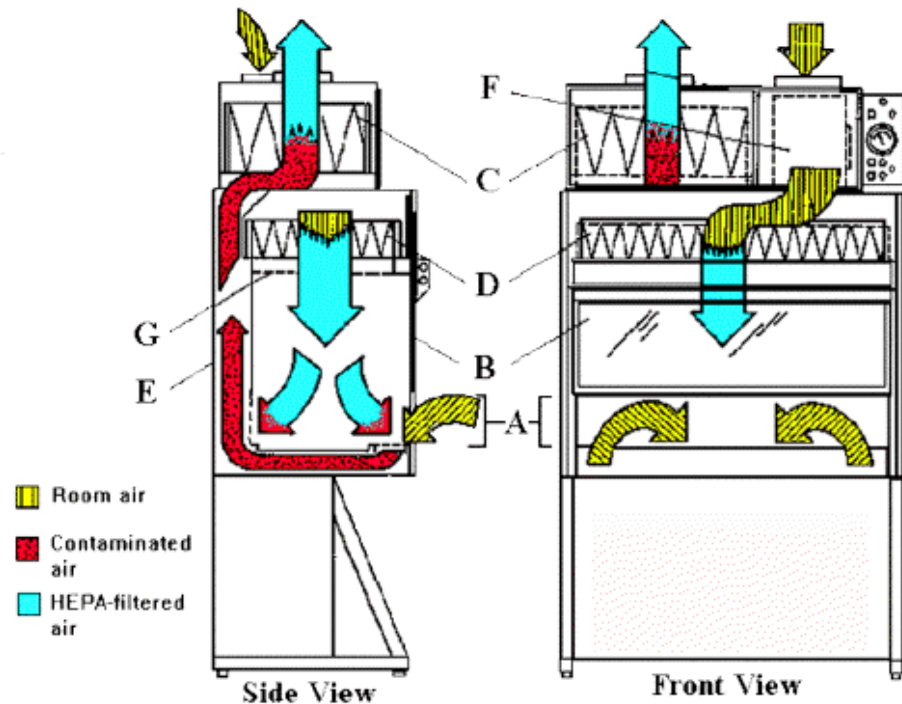

CDC drawings

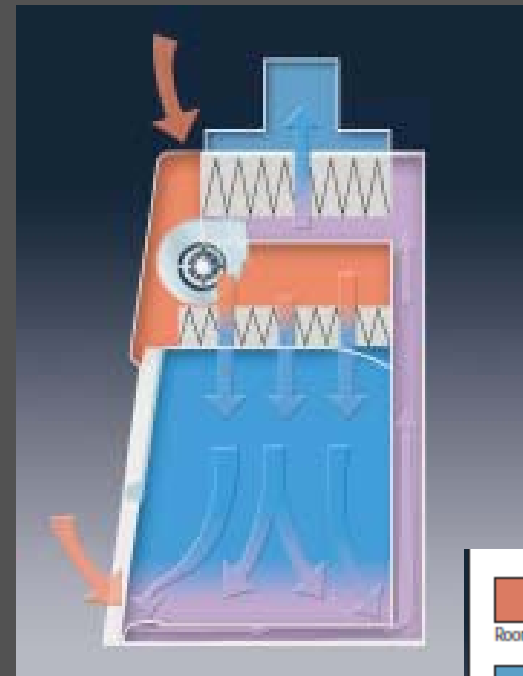

Labconco

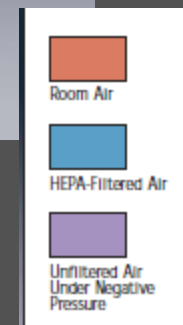

Baker

Class III BSC

- Are totally enclosed
- Ventilated cabinet of gas tight construction
- Works under negative pressure
- Supply air is HEPA filtered
- Exhaust air is filtered by 2 HEPA filters or 1 HEPA filter and incinerated
- 100% exhausted to the outside
- Offers the highest protection
- Work is done through integrated gloves or half suit
- A decontamination chamber must be attached to the BSC
- All equipment is integrated in the BSC



Nuair

Class III BSC

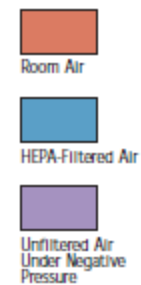
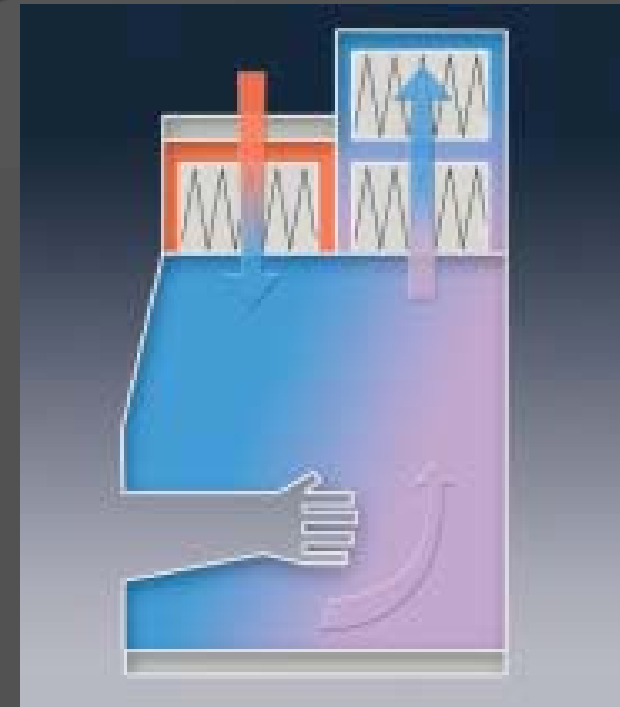
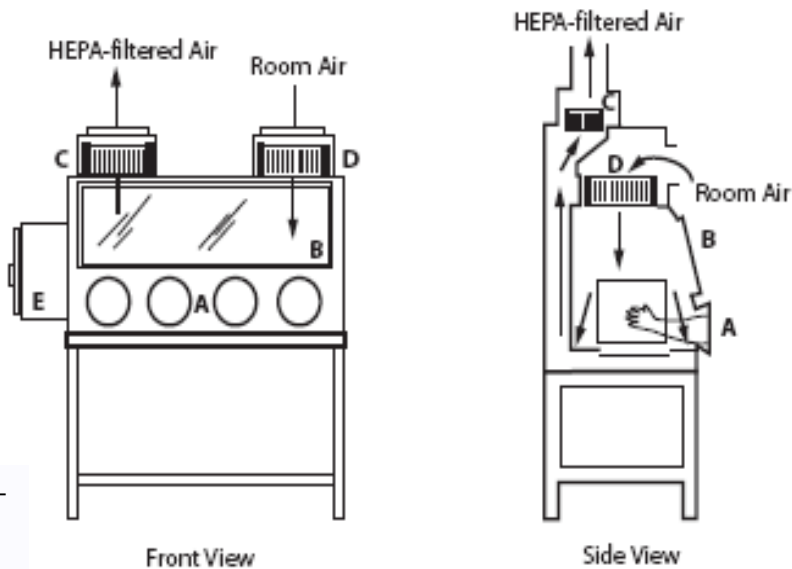

Labconco

- A. Glove ports with O-ring for attaching arm-length gloves to cabinet
- B. Sash
- C. exhaust HEPA filter
- D. supply HEPA filter
- E. double-ended autoclave or pass-through box

Clean Bench (Laminar Flow Cabinet)

- Not to be confused with Class I BSC
- Inflow air is HEPA filtered
- Exhaust air is not filtered
- Used for Microbiology clean preparation (making agar plates) and molecular work (PCR)
- Air flow can be vertical or horizontal

Clean Bench (Horizontal Flow)

A. Front opening, B. supply grille, C. supply HEPA filter, D. supply plenum, E. blower

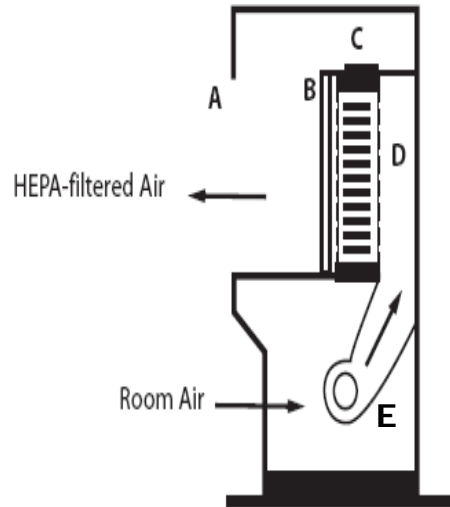

CDC drawing



Labconco

Clean Bench (Vertical Flow)

Concern: looks a lot like a BSC!!!



Labconco

The vertical laminar flow "clean bench". A. front opening, B. sash, C. supply HEPA filter, D. blower. Note: Some vertical flow clean benches have recirculated air through front and/or rear perforated grilles.

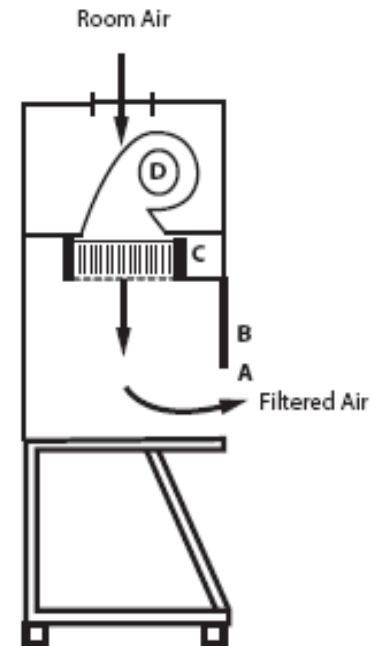

CDC drawing

How are you protected?

A. front opening, B. sash C. exhaust HEPA filter, D. supply HEPA filter,
E. positive pressure plenum, F. negative pressure plenum
NOTE: The cabinet exhaust needs to be connected to the building exhaust system

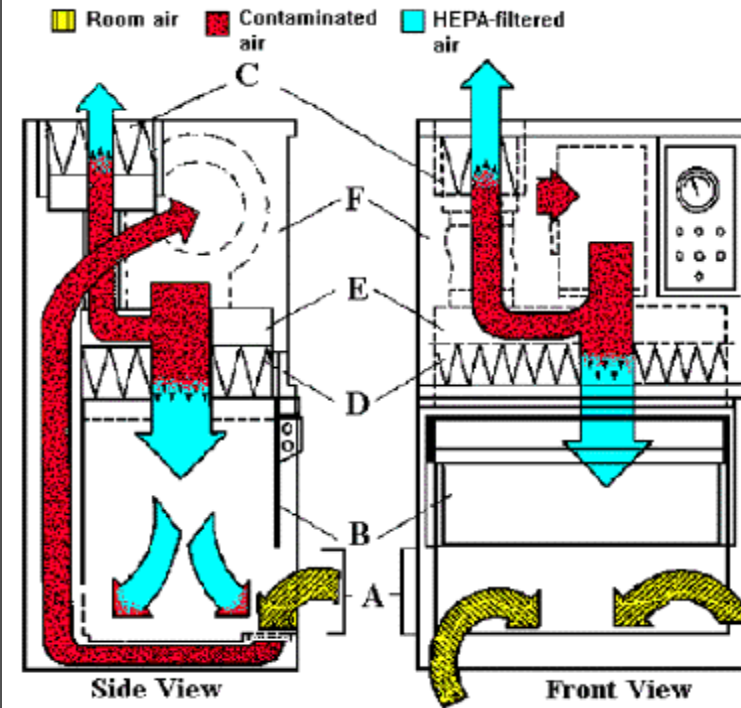

CDC drawing

Other Devices



■ Reverse-flow

- Pull air from front of cabinet thru prefilter and HEPA at rear
- Used to reduce user's exposure to animal urine, dander, etc. (with PPE)
- Not for work with biohazards (no containment)

■ Local exhausts and aerosol collection devices

- Used in laboratories, necropsy/autopsy procedures
- Reduce facility contamination
- May be used with PPE



Chemical Fume Hoods

- Are used for chemical and radioactive work
- Offers no protection to the samples
- Outflow air is exhausted
- In-take velocity differs for combined chemical and radioactive use
- No means of decontamination if used for biohazardous material

Chemical Fume Hoods

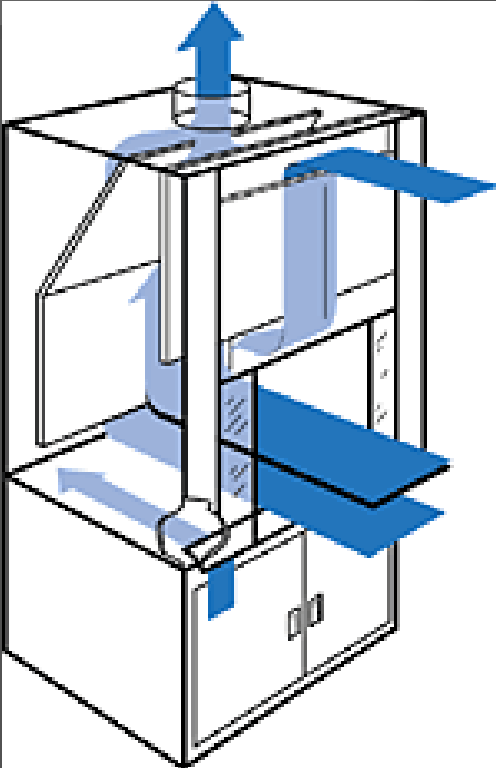

Baker

Look for sash level mark

Proper Use of a BSC

■ Before starting

- If BSC off, turn on 20 min before using for infectious agents
 - Can set up work during this time
- Check the monitors of the BSC

■ Set up work area

- Decontaminate all surfaces of the BSC
 - Walls, work surface, glass
- Place the essential material needed for a specific experiment in the BSC after surface decontamination
- Organize work place
- Wait 5 min before starting work

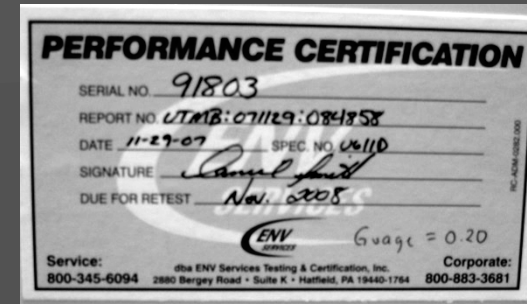

Completion of Work



- Surface decon and remove experimental cultures
- Discard infectious waste into the waste container (located inside BSC)
- Cover, and secure waste containers
- Surface decon all equipment and remove from BSC
- Surface decon and remove waste containers
- Surface decontaminate all surfaces of the BSC
 - Consider use of a dry "Swiffer" to reach all surfaces

BSC Reminders



- Use BSC for manipulating infectious agents or human materials
- Keep work areas free of unnecessary clutter including equipment and supplies.
 - Ignoring this may result in a loss of proper airflow and an increased risk of contamination
- Organize your work time to avoid rushing
- Keep amount of work to be done realistic within the time frame

DO

- **ALWAYS** surface decontaminate all surfaces and material coming out of BSC
- **ALWAYS** change or decontaminate gloves (spray them with disinfectant) before taking hands out of the biosafety cabinet
- Decontaminate any surface, glove, lab coat that may become contaminated by biological material
- Always use mechanical pipetting aids



Drummond

Don't

- Discard materials outside BSC during experiment
- Cross hands while working in the BSC
- Block front and rear intake grills
- Reattach gowns, scratch nose/eyes, get hair out of face with gloves on
- Make sudden swift movements of hands in the biosafety cabinet
- Over-fill waste container
- Do not use Bunsen burners in BSCs
- Work in the BSC if alarm or warning light is on



Remove Material from the BSC

- Paper waste:
 - Sprayed with disinfectant, or,
 - Bagged inside the BSC, sealed and the bag sprayed out
- Biohazardous pipets/tips:
 - Inside rinsed with disinfectant (inside BSC) as used
 - Sprayed, brought out and placed in a lined pipet box, followed by disposal into a medical waste bin
- Biological materials
 - For incubation: wipe down with disinfectant
 - For centrifugation: placed in the rotor inside the BSC, then the rotor is wiped down before removal from BSC



A – disinfectant containing flask

B – overflow flask

C – in-line HEPA filter

D – vacuum system

Vacuum Set-Up

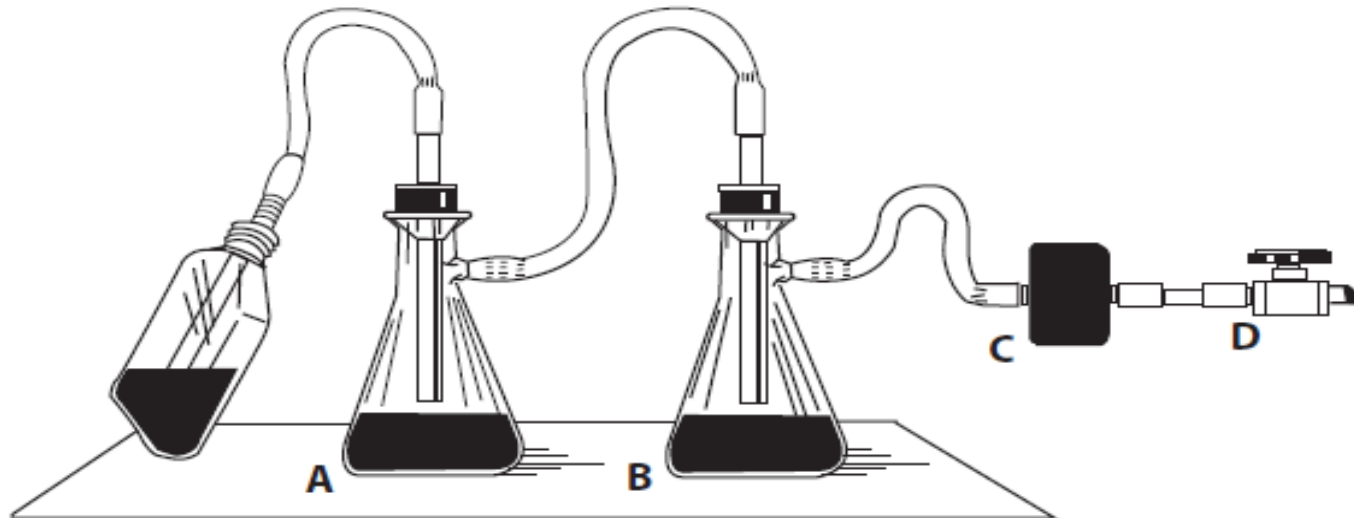

CDC drawing

Flasks should be plastic, plastic-coated glass or covered with netting

UV Lights in the BSC

- Not necessary, if proper aseptic techniques used
- You should **never** have the UV light on when working in the BSC or people are present in the lab
- Lights must be cleaned regularly and tested for efficiency
 - Bulb will glow for 2-3 years
 - Germicidal for only 3-6 months depending on usage
- For UV treatment of cells for mutation, inactivation of biological agents, etc.
 - Use portable UV light source



Aerosol-Producing Procedures

- Centrifuge
- Vortex
- Rocking/shaking cultures
- Lyophilization
- Sonification
- Tissues grinding
- Cell Sorting
- Pipetting
 - Opening tubes



Pipetting



- Open centrifuge tubes carefully
 - Cap openers prevent spills on thumbs
- Pipette in a slow and controlled motion
- Should not hear the “clicking sound” of your pipetter
- Filtered pipette tips do not replace good technique



Centrifuges used for potentially infectious materials

- Sealed or gasketed rotor if run outside of BSC
 - For blood and infectious agents
- If no seals/gaskets
 - Order "safety cups"
 - Load, unload and run inside the BSC



Run in
BSC



Safety cups



Proper Use of Centrifuges

- All personnel must be trained on the proper use of centrifuges.
- ALWAYS:
 - Rotors and seals must be checked before and after each procedure.
 - Check tubes for cracks before and after use.
 - Balance tubes
 - Critical for ultracentrifuges
 - Wait 5 min before opening the centrifuge

Ultracentrifuge destroyed by broken spindle (AIHA)



LAI from Centrifuge Spill



[CDC Home](#)

[Search](#)

[Health Topics A-Z](#)

MMWR™

Weekly

September 02, 1994 / 43(34);635-6

Arenavirus Infection -- Connecticut, 1994

On August 20, 1994, the Connecticut Department of Public Health and Addiction Services received a report of a case of acute illness in a virologist suspected to be associated with Sabia virus, a newly described arenavirus. This report presents preliminary findings from the case investigation.

On August 19, 1994, the virologist presented to the Tropical Medicine Clinic at Yale-New Haven Hospital with a 4-day history of fever, malaise, backache, stiff neck, and myalgias that he attributed to a recurrence of a *Plasmodium vivax* infection. On evaluation at the clinic, his temperature was 99.8 F (37.6 C) on antipyretics, and he had a normal physical examination. Laboratory evaluation included a negative malaria smear, a total white blood cell count (WBC) of 2600 cells/mm³ (normal: 4000-10,000 cells/mm³), a platelet count of 138,000 cells/mm³ (normal: 150,000-350,000 cells/mm³), 2+ proteinuria, and alanine aminotransferase (ALT) of 6356 U/L (upper limit normal: 35 U/L).

A history of a possible laboratory exposure to Sabia virus was obtained, and the man was hospitalized for prompt

Vortex

- **ALWAYS** vortex in the BSC
- Inspect tubes before and after vortexing
- Properly close tubes
 - No thumbs, fingers, etc.
- Do not over-fill tubes
- Ensure proper hold of tube
- One tube at a time
- Vortex slowly



Shaking/Rocking Cell Culture

- Fill liquid 2/3 max
- Flasks must be inspected before and after use
- Flask must be properly secured and labeled
- Mechanical equipment should be in a sealed orbital shaker with transparent lid
- Check often during the day



Tissues Grinders

- Inspect tubes for cracks before and after
- ALWAYS work in the BSC
- Properly secure tube to prevent dropping it
- Do not over-fill tube
- Grind in a slow controlled motion
- Dispose of gloves and pestles properly
- Decontaminate tubes before removing from BSC
- If using a power pestle, control speed properly
- Prevent overflowing

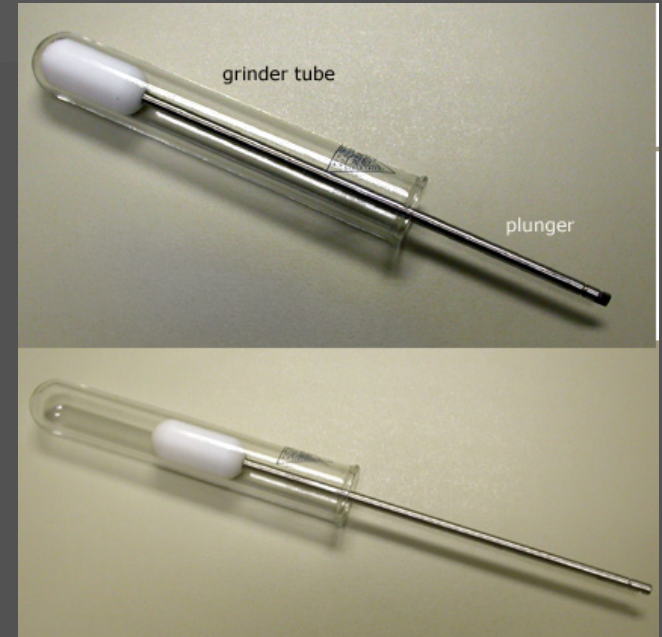

Cell Sorters

- Risk is high with unfixed cells
- Control measures
 - BSL3 recommended unless in containment device
 - Dependent on risk assessment -- BSL2 with BSL3 practices
 - Wear additional PPE (e.g. PAPR, N-95, wrap around gown) and run in a negative pressure facility
 - Use in Neg. pressure device (BSL2)
 - Newer cell sorters designed to fit in BSCs
 - Removable HEPA filtered “hood” also available
 - May have to be built for the application
- Must verify containment with bacteriophage, fluorescent Glo Germ, etc.
- See guidelines
 - <http://www.mrw.interscience.wiley.com/emrw/9780471142959/cp/cpcy/article/cy0306/current/html>



iCyt Reflection Cell Sorter
in Baker BSC

Disinfection

- Solutions most commonly used
 - 10% bleach (freshly made)
 - Other tuberculocidal disinfectant (Cavicide, Wescodyne, Vesphene, etc.)
 - 70% ethanol (kills environmental contamination -- for items going into BSC)



- On what
 - Bench top
 - BSC
 - Fume hoods
 - Centrifuges
 - Equipment
 - Incubators
 - Floors



Disinfection Procedure

■ Centrifuges

- Use damp cloth at the end of each procedure
- Clean Rotors/bucket
 - Inside-at the end of each experiment
 - Outside-wipe each time it is taken out of the BSC

■ Bench top

- Wipe down
 - Before and after each experiment
 - End of the day
 - After a spill

Spill Procedures In a BSC

- Change PPE
- Cover with absorbent material
- Flood area with appropriate disinfectant
- Allow 15 min for disinfectant to be effective
- Call PI
- Decontaminate all material
 - Place cleaning waste into waste container in the BSC
 - Disinfect equipment, remove, and clean the BSC
- Place all waste in red biohazard bag
- Change PPE
- Resume work

Spill Procedures in Centrifuge

- In the BSC, use BSC spill procedure
- Outside of BSC
 - Close centrifuge and stop work immediately
 - Notify co-workers and evacuate lab for 60 min
 - Inform PI, BSO
 - Don necessary PPE
 - Absorb with paper towel, pour disinfectant on spill, and wait ≥ 15 min
 - Clean all potentially exposed surfaces
 - Remove rotor and decontaminate it in BSC
 - Once all surfaces have been properly decontaminated, allow others to return

Spill Procedure in the Laboratory

- **Stop work immediately**
- **Notify other users**
- **Perform first aid immediately**
 - Remove any contaminated clothing
- **Leave the laboratory and wait 60 min**
 - Wash any exposed skin, flood eyes, etc.
- **Notify PI, BSO**
- **Don PPE**
- **Contain spill with absorbent material**
- **Pour disinfectant on spill and wait \geq 15min**
- **Clean-up spill**
 - Remove broken glass (no hands on)
 - Soak contaminated area again with proper disinfectant, wait 30 min
 - Remove waste into biohazard red bag
- **Remove PPE**
- **Return to work**



Cleaning Centrifuge

- Decontaminate rotors, cups, and centrifuge
 - After each work session
 - After a spill
- Bleach solution can be used, but do not soak in bleach (rinse will with water)
- Wipe control panel and centrifuge chamber after each session



Disinfection Procedure

- Chemical hoods

- Wipe down
 - After each experiment
 - Once a month if not used on a regular base



- Floors

- Swept and mopped at least once a week

- Biosafety cabinet

- Surface decontaminated before and after each experiment
- Complete decontamination including underneath the tray - monthly

- Incubators should be decontaminated monthly following the manufacturer's guidelines

Autoclave Procedures

- Autoclave is used primarily for solid waste
- 3 ways to verify the autoclave was run
 - Autoclave tape (each run)
 - Biological/chemical indicator
 - Read printout (each run)
 - Most reliable
 - Indicates temperature, pressure, and time run
- Autoclave malfunction
 - Do not open door (post sign)
 - Notify PI, EH&S



Laboratory Waste



Leakproof
Labeled
Cover



- Gloves
- Plastic Pipettes
- Flasks
- Plates
- Dispensing tips
- Eppendorf tubes
- Any item that appears or has been used in medical research
- Liquid waste
 - Decontaminate all liquids (and contaminated ice)
 - Final 10% bleach dilution – sit for 15 minutes, sewer

Infectious Materials

- Autoclave or chemically disinfect then dispose in the red bin



- Culture dishes, vessels
- Transfer items
- Discarded live and attenuated cultures
- Human blood and blood products
- Tissue specimens (excluding animals parts or carcasses)
- Gloves or other protective equipment

Personal Protective Equipment (PPE)

- PPE ensures that scientists do not contaminate their clothing and body. Can also protect the study material from contamination.
- Types of PPE available
 - Laboratory coats/Gowns
 - Gloves
 - Eye protection
 - Respiratory protection
 - Head covers
 - Foot/leg covers
 - Suits



PPE: Laboratory Coats and Gowns

■ Laboratory coats

- Reusable or disposable.
- Used in BSL1 and 2 facilities.
- Button down the front
- Do not wear in offices, conference rooms, cafeteria, etc.



■ Gowns

- Tyvek suit, disposable lab coat, surgeon's gown
 - BSL3/ABSL3 as required by protocol



Laundry

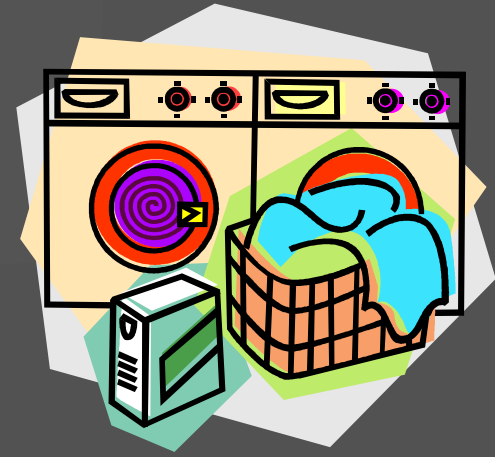

- Collect dirty lab coats/laundry in labeled bags or containers
- Minimal agitation, do not sort at the site
- If you spilled on the lab coat, decontaminate first with bleach or autoclave, or discard
- Never take lab coats or other lab wear home

PPE: Respiratory Protection

■ Types of respiratory protection in AE laboratories

- N95 (Disposable respirator)
- PAPR (Powered Air Purifying Respirator)
 - For those with facial hair or in certain applications requiring additional protection



PAPR

■ Surgical masks (are not respirators)

- Offer minimal protection to the user
- Used for non-respiratory tract infectious agents and splash protection



N95 Respirators

- 95% protection from biological agents
- Tested for protection efficiency
- Prior to use you need
 - A medical evaluation
 - “Fit testing” by EH&S to determine the best model suited for your face shape.
- Used in the BSL3 and ABSL3 facilities
 - Facial hair such as moustaches and beards may prevent the use of these respirators
 - Certain face shapes can also prevent the use of N95



PPE Requirements for BSL2

■ Minimum required

- Laboratory coat
- 1 pair of gloves
- Eye protection
- Closed-toe shoes



■ Specific requirement (work dependent)

- Respiratory protection
- 2 pair of gloves

Gloves



- If you have certain allergies, may be more susceptible to latex allergy
- Check for pinholes before wearing
- Do not touch common items with gloved hands (e.g., door knobs, phones)
- Consider chemical compatibility if applicable
- Waterproof needed for biohazardous work (NOTE: if double gloving, can combine different types like latex & nitrile)
- Wash hands after removing

Additional PPE

- Activity with the potential for a splash or spray

- Filtering under pressure
- Loading columns
- Opening blood tubes
- Running a peristaltic pump



- Wear additional mucous membrane protection

- Face shield
- Mask and goggles
- Visor/mask combo
- Work inside biological safety cabinet (BSC)
- Liquid resistant gowning



Dispo Face shield



Visor/mask combo

Bloodborne Pathogens

(HIV, HBV, HCV + others)



■ Transmitted by:

- Cuts, needlesticks in the work area
- Mucous membrane exposure
- Non-intact skin exposure
 - Hangnails, acne, paper cuts, psoriasis, etc.
- NOT known to be transmitted by aerosol

■ Remember:

- Virtually every disease can be transmitted by a cut or needlestick!

Risks Associated with Bloodborne Pathogens

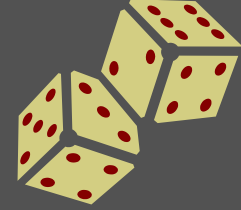

	HBV	HCV	HIV
Seroconversion Rate	15-30%	1.8%	0.3%
Conc/ml of blood	100 million	<1,000	0-3,000
Transmission to newborns	90%	?	30-50% (no treatment)
US Carriers (est.)	1.3 M	4M	1M

Symptoms of a Bloodborne Pathogen Infection

■ HIV

- Flu-like symptoms within several weeks/months after exposure
 - Fever, muscle aches, night sweats, swollen lymph nodes, etc.



■ HBV, HCV

- Most infections are asymptomatic
- Some infections – nausea, jaundice, dark urine (can be weeks/months after exposure)

jaundice

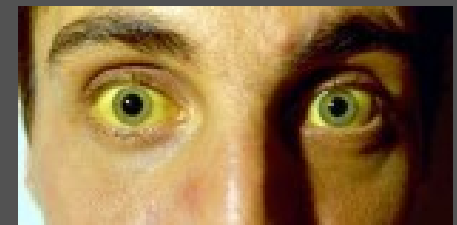

Universal Precautions

- Hand washing for 20 seconds (two rounds of Happy Birthday song)
- No eating, drinking, chewing gum
- Wearing Personal Protective Equipment (PPE)
- Keeping hands away from the face
- Using Engineering Controls (e.g., BSCs)
- Minimizing aerosol formation
- Wiping down work area with disinfectant



Examples of Sharps Alternatives

- Hypodermic needles
 - Use safe needles or safe syringes
 - Point-lok for any needle size
- Pasteur pipet
 - Use plastic transfer pipet
- Scissors
 - Use blunt-tipped safety scissors
- Glassware
 - Use plastic or plastic-coated glass

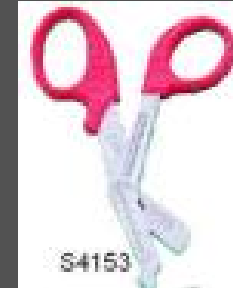
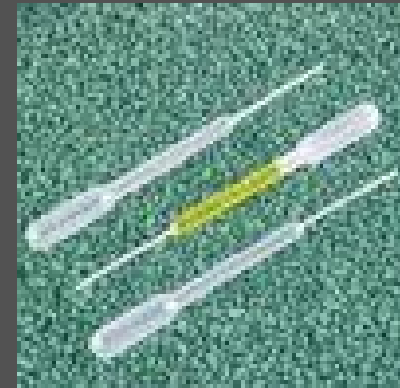

Labeling Requirements

What needs a biohazard label?

- Room doors if work with infectious agents/human samples
- Freezers/refrigerators/incubators used to store infectious agents or human samples
- Biowaste containers (cans, sharps containers, pipet boxes)
- Shipping containers for same
- Materials for storage (vials or secondary containers)

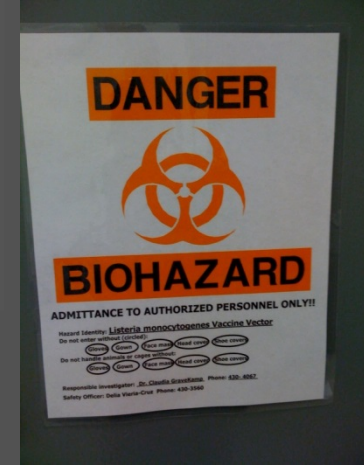

Transporting Material between Laboratories

- Double packaged in a sealed container
- Liquids in spill proof container with absorbent material
- Then placed in a secondary sealed container for transportation
 - Label with biohazard symbol
 - Decontaminate outside (no gloves!)
 - Do not take to non-lab areas or leave unattended
- No transporting of human samples or infectious agents in personal vehicles or passenger shuttle
 - Use courier service
 - Transport by hand



Ziploc with sample and absorbent

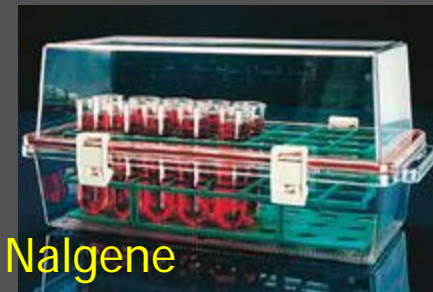

Nalgene

Shipment Off Campus

- Shipment of biological samples off campus is strictly regulated
 - DOT (Department of Transportation)
 - IATA (International Air Transport Assoc.)
 - CDC (Center for Disease Control)
 - USDA (US Department of Agriculture)
 - Department of Commerce
- You must be certified to ship hazardous goods and infectious agents
 - Retraining every 2 years (contact EH&S)
 - Strict fines for breaking regulations

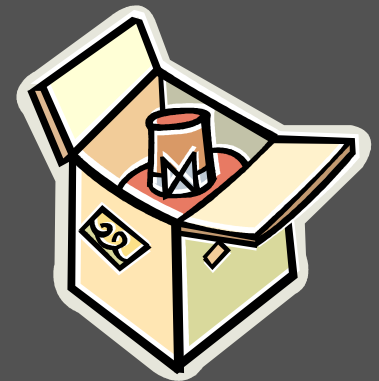

Hepatitis B Vaccine Information

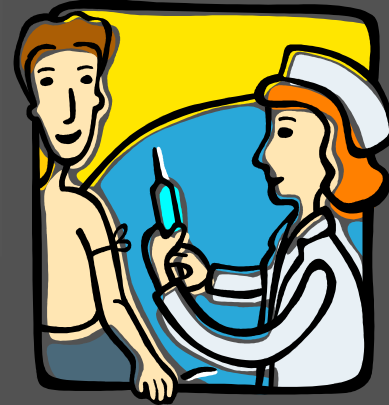

- Yeast-based vaccine
 - No vaccination if sick/pregnant/allergic to yeast
 - 3 shots over 6 month time period
 - Post series antibody check
 - Side effects usually minimal
 - Can decline vaccine if sign the decline form
 - Can get vaccine any time if still have exposure

Biological Exposures

- **When using human samples**
 - Always consider them potentially infected (Universal Precautions)
 - Take Bloodborne Pathogen training annually
 - All exposures are reported to PI, Occ Health and EHS
 - Incident evaluation
 - Blood collection of exposed employee and source individual testing (if possible)
 - Counseling of exposed individual
 - Prophylactic treatment offered, if appropriate
 - Reporting of test results



Lab Vaccinia infection
Journal of Investigative
Dermatology

What can you do?

- **Know your infectious agent**
 - Incubation period, symptoms, mode of transmission, etc.
 - Check out Canadian MSDSs for infectious agents
 - <http://www.phac-aspc.gc.ca/msds-ftss/index-eng.php>
- **If you think you were exposed to an infectious sample by direct contact or aerosol**
 - Report it immediately to PI, Occ Health and EHS.
 - Monitor for signs of illness and report them immediately

Medical Restrictions

- Report to your PI or Occ Health in order to conduct a risk assessment if you are working with infectious agents and you are:
 - Immunosuppressed
 - Medication
 - Condition
 - Pregnant
 - Using mind altering medications
 - Including over the counter drugs
 - Have open wounds or lacerations



Occupational Health Services

- **1180 Morris Park Ave**
 - Monday-Friday, 8:00AM-4:00PM
 - (Closed for lunch Noon-1:00PM)
 - (347) 498.2401
- **219H Block Building**
 - Monday-Friday, 9:00AM-5:00PM
 - (Closed for lunch 1:00PM-2:00PM)
 - (718) 430-3141

Emergency Rooms

Weiler Hospital
Jacobi Hospital



Questions?



Lab Safety Officer

Delia Vieira-Cruz x3560

Acting BSO – Marian Downing

Call x3560 for copies of slides

